



ACC Bottle Plates

K2 Engineering's Newest Innovation...

K2 Engineering Group offers several different types of bottle plates that are sure to meet your needs. If you are looking for bottle plates for your Kronen™ equipment, we can provide direct replacements. If you are having trouble identifying which plate is for what package, upon request we can engrave the plates with package designation and/or use colored plugs to help decipher various packages.

Adjustable Compression Coupler

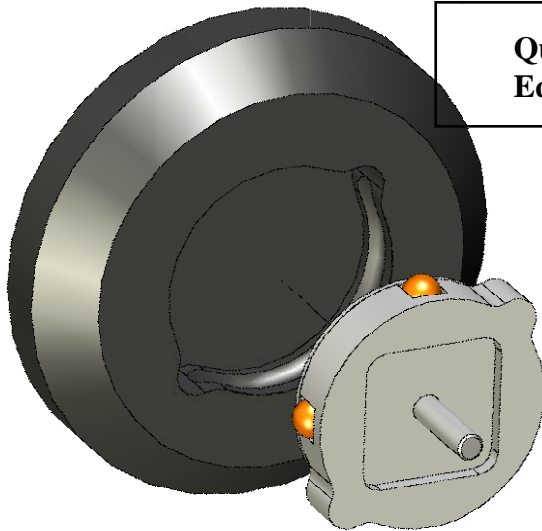

Quick Change Bottle Plate Retro-fit to Existing Kronen™ Equipment with Square Drive Shaft Bottle Plates

- **Direct Replacements with One Time Purchase of Quick Change Adapters**
- **No Tools Required for Bottle Plate Changeover**
- **No Dead Plate Adjustments Required**
- **No Springs or Levers to Clog or Jam**
- **Add or Remove Plates to Adjust the Holding Force**
- **Option of Plug Color Coding**
- **Custom Engraving**
- **Two Piece Bottle Plate with Replaceable Inserts**
- **Cost Effective**

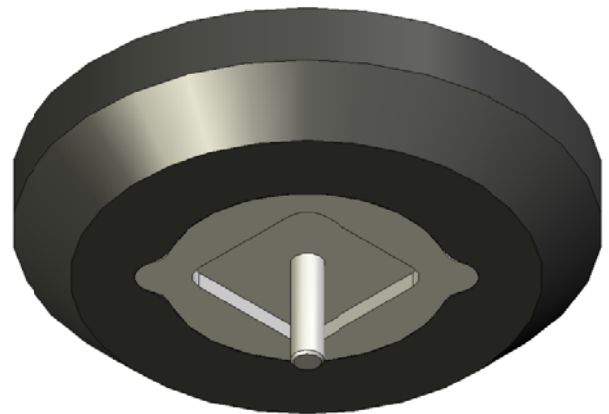

To see K2's complete list of other available bottle plates see reverse side.

Not sure which Bottle Plate you need, give our office a call at 262-662-3452 or email us at sales@k2egroup.com...

Bottle Plate Designs by K2 Engineering Group

SD2P

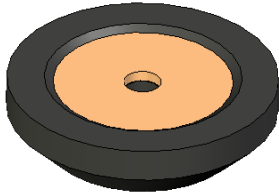

- **General Purpose Square Drive Bottle Plate Normally used with Glass and PET Bottles**

SD2PID

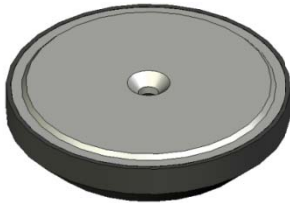

- **Square Drive Bottle Plate Generally used with 3 Piece Cans or 2 Piece Cans Running Chime or Pull Tab Down**

QC2PP

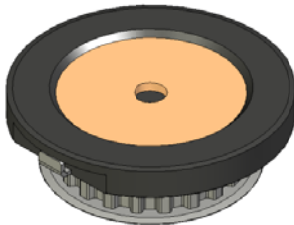

- **Krones™ Quick Release Style Plate or Post Mount Bottle Plate with Outside Diameter Centering, Usually used with Glass or PET Containers**

SD2PG

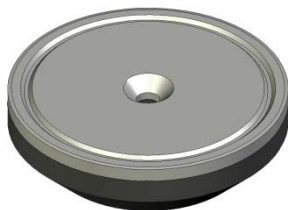

- **Square Drive Bottle Plate used for Smaller Can Operations when the need to Span Dead Plate Distances and label Placement Tolerances are Required**

QC2PPID

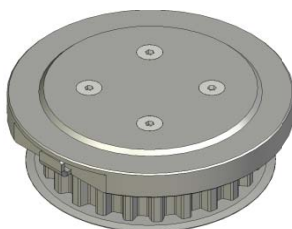

- **Krones™ Quick Release Style Post Mount Plate; this has Inside Diameter Centering and is Generally Stainless for High Speed Machines Running Cans with the Pull Tab Down or 3 Piece Cans**